

Catálogo General



MEXBUSA



AUDIO



PMX-4150
Mezcladora amplificada de 4 canales.

- 4 entradas balanceadas XLR, 4 entradas de línea de 6.3 mm
- 2 Bandas de ecualización agudos-graves por canal
- Amplificador Clase AB de 150 W RMS



PMX-8180
Mezcladora amplificada de 8 canales.

- 8 entradas balanceadas XLR, 4 entradas de línea de 6.3 mm
- 2 Bandas de ecualización agudos-graves por canal
- Amplificador Clase AB de 180 W RMS

Funciones:



- Ecualizador gráfico de 5 bandas
- Controles de graves y agudos por canal
- Modos de reproducción Bluetooth, SD, USB
- 1 control de efecto por canal
- Display
- Transformador toroidal de alto desempeño
- Alimentación: 127 Vca 60 Hz
- Chasis de plástico texturizado de alto impacto



35x21.5x21.5 cm



Control remoto.



Diagrama interior.



Panel trasero

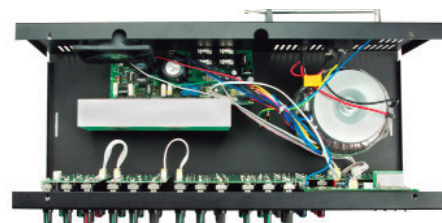

45x21.5x 21.5 cm



Caja con 1 pieza



1 pieza



Complementa con:



RKS-2015AS
Bafle amplificado semi-profesional de 3 vías.



MS-AP1
Filtro antipop para micrófono.



MC-58
Micrófono vocal de alta precisión.



MS-405BK
Cable de audio con conectores TS de 6.3 mm con un conector en L reforzado.



MX-602BT

Mezcladora pasiva de 6 canales.
2 canales balanceados mono + 2 canales estéreo.



Control remoto

MX-802BT

Mezcladora pasiva de 8 canales.
4 canales balanceados mono + 2 canales estéreo.



Complementa con:



RKS-2015P
Bafte pasivo tipo torre, con doble woofer de 15".



CA-162
Cable de audio de conector XLR a conector TS de 6.3 mm. De 3.6m



MC-214BL
Micrófono dinámico con acabado satinado.



MS-492BK
Cable de audio profesional con conectores XLR. De 6m



Funciones:

- Ecuador paramétrico de 3 bandas por canal
- Ecuador gráfico de 5 bandas
- Modos de reproducción Bluetooth, SD, USB
- Control de 16 efectos
- Display
- Alimentación: 127 Vca
- Chasis metálico con tapas laterales de plástico mate



24.5x24x9 cm



Panel trasero



31x24x9 cm



Caja con 1 pieza



1 pieza



Escanea el código y mira su funcionamiento.



Funciones:



● **MX-4CH**

Mezcladora pasiva de 4 canales.

- 2 canales balanceados mono/ 2 canales estéreo
- 2 entradas combo XLR/ TRS
- Ecualizador paramétrico de 2 bandas por canal
- Entrada y salida auxiliar
- Chasis plástico
- Phantom power
- Consumo: 5 W
- Tres formas de alimentación USB:

- *Vía ordenador
- *A corriente eléctrica
- *Power bank



Caja con 1 pieza



1 pieza

Compatibilidad:



MEZCLADORAS DE AUDIO

Catálogo General MEXBUSA

Sonido que apasiona **ROMMIS**

NUEVO



MX-10CH
Mezcladora pasiva
de 10 canales



MX-12CH
Mezcladora pasiva
de 12 canales



MX-16CH
Mezcladora pasiva
de 16 canales

Características generales:

- Ecualizador semiparamétrico de 3 bandas
- Procesador SPX de 24 programas
- Sample rate 24-bit/192 kHz
- Chasis metálico



AUDIO

5

ESPECIFICACIONES	MX-10CH	MX-12CH	MX-16CH
Entradas de micrófono	4 (4 mono + 3 estéreo)	6 (4 mono + 4 estéreo)	10 (8 mono + 4 estereo)
Bus de grupo	NA	2	4
Bus estéreo	1	1	1
Envíos AUX	1	2	4
Phantom Power	48 V	48 V	48 V
Peso neto	1.9 kg	4.2 kg	6.8 kg



Caja con
1 pieza

MIN
VENTA

1 pieza

Sonido que apasiona

ROMMIS



PA-R100MP3

Amplificador de 100 W RMS

- Clase AB
- Puede funcionar con una batería sellada de 12 Vcc
- Volumen independiente de MIC 1, MIC 2
- Entrada auxiliar
- Reproductor de mp3
- Controles de graves y agudos
- Salida de voltaje a 70 y 100 V
- Salidas amplificadas a 4, 8 o 16 Ω
- Alimentación: 115 Vca @ 60 Hz / 230 Vca @ 50 Hz / 12 Vcc
- Chasis metálico



Funciones:



3 entradas

Puede funcionar con una batería sellada de 12 Vcc.



PA-R450MP3

Amplificador de 45 W RMS

- Volumen independiente de reproductor, cable auxiliar y micrófonos
- Controles de graves y agudos
- Salida de voltaje a 100 V
- Salidas amplificadas a 4 a 16 Ω
- Alimentación: 110 Vca @ 50-60 Hz / 12 Vcc
- Incluye control remoto
- Chasis metálico

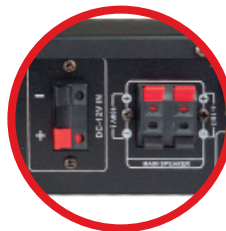

Funciones:



1 entrada
1 salida

2 entradas

Puede funcionar con una batería sellada de 12 Vcc



PA-2180

Amplificador de audio ambiental multizona de 180W RMS

Los amplificadores de publidifusión se adaptan a diversos usos como voceo, sonorización y ambientación de espacios. Destacan sus controles de tonos independientes, entradas para micrófonos y para otros dispositivos que desees reproducir.

Especificaciones:

- Clase AB
- Con reproductor Bluetooth, USB, SD
- Ecuador de 3 bandas
- 2 Transformadores toroidales
- Cuenta hasta con 6 "zonas"
- Salidas de voltaje a 70 y 100 V
- Salidas amplificadas a 4 y 16 Ω
- Incluye control remoto
- Chasis metálico
- Enfriamiento por ventilador de velocidad variable
- 3 entradas de micrófono y de línea
- Protección contra corto circuito por medio de relay
- Alimentación: 127 Vca @ 60 Hz
- Montaje en rack de dos unidades
- Peso: 9.5 kg
- Medidas: 480 x 370 x 88 mm

Panel trasero



Interior:

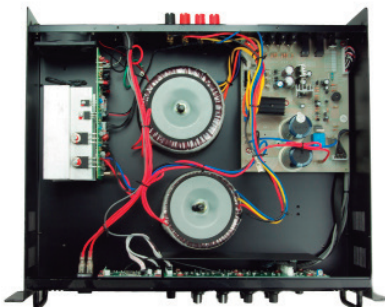

Funciones:



Complementa con:



SC-120
Columna sonora de 20 W.



SC-140
Columna sonora de 40 W.



MS-404
Cable de audio con conectores TS de 6.3 mm Puntas doradas.



MC-58A
Micrófono vocal de alta precisión.



RKS-2015P
Bafle pasivo tipo torre, con doble woofer de 15".



CA-228RL
Extensión RCA con 2 conectores macho en cada extremo. De 8 mm.



CMF-2X24RD
Rollo con cable para micrófono marca Rockers.

Visita nuestro Catálogo de Cables



300 W
RMS



RKS-2015AS

Bafle amplificado semi-profesional de 3 vías.

- Tipo torre
- Cuenta con doble woofer de 15"
- Imán de 40 Oz
- Bobina de voz de 2"
- Driver de titanio de 34 mm
- Display LCD
- Ecualizador gráfico de 5 bandas
- 1 Salida activa Speak-On
- Control remoto
- Ecualizador gráfico de 5 bandas
- Ecualizador digital en modo BT, USB
- Resistente cubierta de plástico texturizado de alto impacto
- Rejilla metálica
- Manijas y ruedas para fácil transportación
- Medidas: 40*50*114 cm
- Peso aproximado: 27.5 kg

Funciones:



Micrófonos:



1 entrada 1 salida 1 entrada



2 entradas 2 entradas

¡Descubre tu talento!
Míralo en acción.





300 W
RMS



RKS-2015P

Bafle pasivo semi-profesional de 3 vías.

Tipo torre.
Cuenta con doble woofer de 15"

Puedes conectarlo:

- A un bafle activo RKS-2015AS
- A un amplificador PA-R600
- A una mezcladora amplificada PMX-8180

- Imán de 40 Oz. Bobina de voz de 2"
- Driver de titanio de 34 mm
- Entrada y salida Speak-On
- Resistente cubierta de plástico texturizado de alto impacto
- Rejilla metálica
- Manijas y ruedas para fácil transportación
- Medidas: 40*50*114 cm
- Peso aproximado: 24.5 kg



Complementa con:



PMX-8180
Mezcladora amplificada de 8 canales.



MS-634
Cable de audio de conector Speak-On macho a conector TS de 6.3 mm



MC-328
Sistema dual de micrófonos inalámbricos UHF.



MS-102
Pedestal para micrófono con seguro de presión.

30 W
RMS



20 W
RMS



40 W
RMS



SC-115

Par de altavoces de 30 W
Para ambientación.

- 1 bocina de 5 1/4"
- Tweeter de 1"
- Terminales: Bornés
- Incluye accesorios de montaje
- Cuerpo de plástico
- Malla metálica
- Protección IP-61 para uso en interiores y exteriores techados
- Rango de frecuencia: 70 Hz-20 kHz
- Presión de sonido: 91 dB
- Switch selector de 8 Ω, 70-100 V



70/100 V



25x18.3x16.4 cm



Caja con 1 par



6 kg (par)



1 par

SC-120

Columna sonora de 20 W.
Para ambientación.

- 2 bocinas de 4"
- Incluye accesorios de montaje
- Cuerpo de aluminio
- Malla metálica
- Protección IP-61 para uso en interiores y exteriores techados
- Rango de frecuencia: 70 Hz-15 kHz
- Presión de sonido: 91 dB



70/100 V



32x13.2x13.3 cm



Caja con 1 pieza



2.7 kg



1 pieza

SC-140

Columna sonora de 40 W.
Para ambientación.

- 4 bocinas de 4"
- Incluye accesorios de montaje
- Cuerpo de aluminio
- Malla metálica
- Protección IP-61 para uso en interiores y exteriores techados
- Rango de frecuencia: 70 Hz-15 kHz
- Presión de sonido: 94 dB



70/100 V



56x13.2x11.3 cm



Caja con 1 pieza



4.3 kg



1 pieza



Complementa con:



PA-2180

Amplificador de audio ambiental de 180W RMS



CMF-CR2X24WH

Rollo con cable para micrófono marca Rockers.

Visita nuestro Catálogo de Cables



• Sistema profesional de micrófonos inalámbricos UHF de dos canales de frecuencias fijas.

Para su operación con amplificadores, altoparlantes, karaokes, grabadoras de voz, entre otros.

Contenido:

- 1 receptor UHF
- 1 eliminador de 12 Vcc 500 mA
- 1 cable TS de 6.3 mm de 1 m
- Instructivo de Uso
- **MC-630L:** 1 micrófono de mano, 1 micrófono lavalier
- **MC-630M:** 2 micrófonos de mano
- **MC-630LD:** 1 micrófono de diadema, 1 micrófono lavalier

- Micrófonos con filtro de reducción de ruido
- Alcance ±50 m
- Respuesta de frecuencia: 50 Hz-15 KHz
- Impedancia: 600 Ω
- Transductor dinámico de bobina móvil
- Rango dinámico: >100 dB
- Sensibilidad: ±105 dB

UHF



50 m



Caja con 1 pieza

MIN VENTA

1 pieza

MC-630M



MC-630L



MC-630LD





80 m



80 m



80 m

MC-318

Sistema dual de micrófonos inalámbricos UHF, con display de 2.5"

- Micrófonos con filtro de reducción de ruido
- Pueden ser usados al mismo tiempo sin interferencia
- Volumen independiente para cada uno
- Micrófonos funcionan con 2 baterías AA
- Eliminador de 12 Vcc/ 500 mA para el receptor
- Cable TS 6.3 mm de 1 m
- Impedancia: 600 Ω
- Sensibilidad: -60 ±3 dB
- Resp. de frecuencias: 70 Hz-13 kHz
- Rango dinámico: 80 dB

UHF



Caja con 1 pieza

MIN VENTA

1 pieza

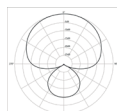

Supercardioid

MC-324

Sistema dual de micrófonos inalámbricos UHF

- Micrófonos con filtro de reducción de ruido
- Pueden ser usados al mismo tiempo sin interferencia
- Volumen independiente para cada uno
- Micrófonos funcionan con 2 baterías AA
- Eliminador de 12 Vcc/ 500 mA para el receptor
- Cable TS 6.3 mm de 1 m
- Impedancia: 600 Ω
- Sensibilidad: -60 ±3 dB
- Resp. de frecuencias: 70 Hz-13 kHz
- Rango dinámico: 80 dB

UHF



Caja con 1 pieza

MIN VENTA

1 pieza



Supercardioid

MC-328

Sistema dual de micrófonos inalámbricos UHF, con display de 3.5"

- Micrófonos con filtro de reducción de ruido
- Pueden ser usados al mismo tiempo sin interferencia
- Volumen independiente para cada uno
- Micrófonos funcionan con 2 baterías AA
- Eliminador de 12 Vcc/ 500 mA para el receptor
- Cable TS 6.3 mm de 1 m
- Impedancia: 600 Ω
- Sensibilidad: -60 ±3 dB
- Resp. de frecuencias: 70 Hz-13 kHz
- Rango dinámico: 80 dB

UHF



Caja con 1 pieza

MIN VENTA

1 pieza

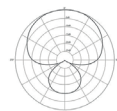

Supercardioid



OFERTA



MC-530

Sistema dual de micrófonos inalámbricos UHF.

- Micrófonos con filtro de reducción de ruido
- Pueden ser usados al mismo tiempo sin interferencia
- Volumen independiente para cada uno
- MUTE en cada micrófono.
- Micrófonos funcionan con 2 baterías AA
- Eliminador de 12 Vcc/ 500 mA para el receptor
- Indicador de carga de batería
- Impedancia: 600 Ω
- Sensibilidad: -100 \pm 3 dB
- Resp. de frecuencias: 60 Hz-18 kHz
- Rango dinámico: 80 dB



80 m



UHF



Caja con 1 pieza



MIN VENTA

1 pieza



Supercardioid

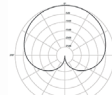

Cardioid

MC-209

Micrófono dinámico unidireccional.

- Cuerpo metálico
- Con filtro de reducción de ruido
- Con switch de encendido
- Antiderrapante
- Impedancia: 600 Ω
- Transductor: Dinámico de bobina móvil
- Sensibilidad: -73 \pm 3 dB
- Resp. de frecuencia: 80 Hz-15 kHz
- Estuche tipo maletín



6.3 mm
XLR a TS de 6.3mm



5 m



Caja con 1 pieza



MIN VENTA

1 pieza

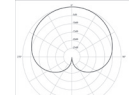

Cardioid

MC-213

Micrófono profesional dinámico. Con control de volumen.

- Acabado metálico
- Con filtro de reducción de ruido
- Con switch de encendido
- Antiderrapante
- Impedancia: 600 Ω
- Transductor: Dinámico de bobina móvil
- Sensibilidad -76 \pm 3 dB
- Resp. de frecuencia: 50 Hz-15 kHz
- Estuche tipo maletín



XLR



5 m



Caja con 1 pieza



MIN VENTA

1 pieza



Cardioid

MC-285

Micrófono semiprofesional.

- Acabado metálico
- Con filtro de reducción de ruido
- Con switch de encendido
- Antiderrapante
- Impedancia: 600 Ω
- Transductor: Dinámico de bobina móvil
- Sensibilidad: -78 \pm 3 dB
- Resp. de frecuencia: 55 Hz-15 kHz
- Estuche tipo maletín



6.3 mm
XLR a TS de 6.3mm



5 m



Caja con 1 pieza



MIN VENTA

1 pieza

OFERTA

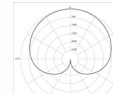

Cardioid

MC-214BK

MC-214BL

Micrófono dinámico. Acabado satinado.

- Antiderrapante
- Impedancia: 600 Ω
- Transductor: Dinámico de bobina móvil
- Sensibilidad -73 \pm 3 dB



6.3 mm
XLR a TS de 6.3mm



3 m



Caja con 1 pieza



MIN VENTA

1 pieza



Cardioid

MC-230

Micrófono dinámico. Alámbrico e inalámbrico.

- Efecto de Eco
- Transductor: Dinámico de bobina móvil
- Impedancia: 600 Ω
- Resp. de frecuencia: 120 Hz-9 kHz
- Sensibilidad: -78 \pm 3 dB



6.3 mm
XLR a TS de 6.3mm



4 m



Caja con 1 pieza



MIN VENTA

1 pieza



¡Descubre tu talento!
Míralo en acción.

MC-57

Micrófono dinámico para instrumentos.

- Micrófono con filtro de reducción de ruido
- Acabado metálico
- Diseño ligero y resistente
- Incluye cable XLR balanceado (de 4 m)
- Impedancia: 600 Ω
- Transductor: Dinámico de bobina móvil
- Sensibilidad: -75±3 dB
- Resp. de frecuencias: 40 Hz-15 KHz



Supercardioid



Caja con 1 pieza



1 pieza

MC-58

Micrófono vocal de alta precisión. Super cardioid, ideal para voces e instrumentos.

- Micrófono con filtro de reducción de ruido
- Acabado metálico
- Incluye cable XLR a TS 6.3 mm
- Impedancia: 600 Ω
- Transductor: Dinámico de bobina móvil
- Sensibilidad: 49±3 dB
- Resp. de frecuencias: 60 Hz-15 kHz



Supercardioid



Caja con 1 pieza



1 pieza

MC-58A

Micrófono vocal de alta precisión. Super cardioid ideal para voces e instrumentos.

- Micrófono con filtro de reducción de ruido
- Con switch de encendido
- Acabado metálico
- Incluye cable XLR balanceado (de 4 m)
- Incluye funda de vinipiel y clip
- Impedancia: 600 Ω
- Transductor: Dinámico de bobina móvil
- Sensibilidad: 49+- 3 dB
- Resp. de frecuencias: 60 Hz-15 kHz



Supercardioid



Caja con 1 pieza



1 pieza



Accesorios incluidos:



MS-102



Cromado

Altura:
de 90 a 160 cm



MS-102RD



MS-102BL



MS-102YE

● Pedestal para micrófono con seguro de presión.

- 2 secciones
- Boom de fijación de 80 cm en dos secciones con perillas para ajustar inclinación
- Base tipo tripié con gomas antiderrapantes
- Guía de cable y adaptador para clip
- Fabricado con materiales de alta resistencia





Altura:
de 83 a 155 cm

Cromado



Altura:
de 90 a 160 cm

MS-101

● Cromado

MS-101BK

●

Pedestal para micrófono con base redonda.

- 2 secciones para ajustar la altura
- Guía de cable y adaptador para clip
- Base redonda: 25 cm



Caja con 1 pieza

MIN VENTA

1 pieza

MS-103

● Cromado

MS-103BK

●

Pedestal para 2 micrófonos. Con 2 secciones y boom.

- Boom de fijación central de 80 cm con perillas de ajuste
- Base: Tipo tripié con gomas antiderrapantes
- Guía de cable y adaptadores para clip



Caja con 1 pieza

MIN VENTA

1 pieza



Altura:
de 90 a 160cm



MS-112BK

Pedestal para 2 micrófonos.

- Boom de fijación superior de 80 cm con perillas de ajuste
- Base: Tipo tripié con gomas antiderrapantes
- Línea estándar
- Incluye: Guía de cable y clips para micrófonos



Caja con 1 pieza

MIN VENTA

1 pieza

PEDESTALES Y ACCESORIOS

Catálogo General MEXBUSA

Sonido que apasiona **ROMMIS**



MS-188

Clip ajustable para tableta.

- Gomas de caucho para mejor cuidado y ajuste
- Fabricado en metal y materiales de alta resistencia
- Expandible de 6 "a 12"

MS-189

Clip para celular.

- Giro de 360°
- Fabricado en metal y materiales de alta resistencia

MS-190

Clamp para pedestal.

- Gomas de caucho para mejor cuidado y ajuste
- Fabricado en metal y materiales de alta resistencia

MS-AP1

Filtro antipop para micrófono.

- Diámetro: 15 cm
- Longitud de cuello de ganso: 34 cm
- Clamp para pedestal
- Ligero, portátil y plegable
- Materiales de alta calidad y gran resistencia



Caja con 1 pieza

MIN VENTA

1 pieza



Caja con 1 pieza

MIN VENTA

1 pieza



Caja con 1 pieza

MIN VENTA

1 pieza



Blister con 1 pieza

MIN VENTA

1 pieza



Complementa con:



MS-184BK
Cuello de ganso para micrófono.



MS-140
Clip expandible para micrófono.



MS-103
Pedestal para 2 micrófonos con boom.



MC-58A
Micrófono vocal de alta precisión.



Caja con 1 pieza



1 pieza

- MS-114**
Pedestal de mesa con base metálica redonda para micrófono.

- 2 secciones. - Base de 16cm
- Altura ajustable de 27 hasta 40cm
- Incluye guía de cable y adaptador para clip
- Fabricado con materiales de alta resistencia



Caja con 1 pieza



10 piezas

- MS-116**
Pedestal de mesa con tubo flexible y base metálica

- Cuello de ganso macho-hembra
- Altura de 18cm
- Base de 14.5cm
- Fabricado con materiales de alta resistencia



Caja con 1 pieza



1 pieza

- MS-119**
Pedestal de dos secciones, con boom para micrófono.

- Altura: 60cm - Base de 16cm
- Longitud del boom: 45cm
- Boom con perillas de inclinación.
- Incluye guía de cable y adaptador para clip
- Fabricado con materiales de alta resistencia



Caja con 1 pieza



1 pieza

- MS-26E**
Pedestal de mesa con base redonda para micrófono.

- Altura ajustable hasta 37 cm
- Diámetro de base: 11.5 cm
- Posición de micrófono ajustable
- Fabricado con materiales de calidad y resistencia



Bolsa con 1 pieza



1 pieza

- MS-184**
MS-184BK
Cuello de ganso para micrófono.

- Longitud: 30 cm - Flexible
- Macho-hembra - Acabado metálico



Bolsa con 10 piezas



10 piezas

- MS-100**
Adaptador para base de micrófono.

- De 3/8 a 5/8. Para modelo MS-138



Caja con 1 pieza



1 pieza

- MS-111**
Pedestal mini, tipo tripié.

- Para exhibidor o mesa
- Altura: 8.5 cm
- Gomas antiderrapantes



Bolsa con 1 pieza



1 pieza

- MS-136**
Clip de presión para micrófono.

- Estándar
- Fabricado en plástico ABS



Bolsa con 1 pieza



1 pieza

- MS-138**
Clip de presión reforzado para micrófono.

- Tamaño Jumbo



Bolsa con 1 pieza



1 pieza

- MS-140**
Clip expandible para micrófono.

- Ancho: 30 mm
- Fabricado en plástico ABS

PEDESTALES Y ACCESORIOS

Catálogo General MEXBUSA

Sonido que apasiona **ROMMIS**



MS-213BK

MS-213BL

MS-213RD

MS-213YE

● Pedestal de piso para instrumento.

- Altura: 43 cm
- Amplitud: Máximo 32 cm
- Gomas antiderrapantes
- Brazos y perilla de seguridad cubiertos en goma antiderrapante



Caja con 1 pieza



1 pieza



Altura:
De 48 a 60cm

● **MS-215**

Pedestal para instrumento con base tipo tripié.

- Altura ajustable. -Seguro para diapasón
- Amplitud: Máximo 32 cm
- Base con protectores antiderrapantes
- Soporte y seguro cubiertos con goma antiderrapante



Caja con 1 pieza



1 pieza



● **MS-211**

Soporte de pared.

- Almohadilla para protección del instrumento.
- Metálico



Bolsa con 1 pieza



1 pieza



● **MS-212**

Soporte para panel ranurado.

- Almohadilla para protección del instrumento
- Metálico



Bolsa con 1 pieza



1 pieza



Altura:
1.20 m



Compartimiento para brazos.



Gomas antiderrapantes.



Brazos desmontables.



Vástago para boom.



MS-120BK

MS-120BL

MS-120CO

MS-120SI

MS-120RD

Pedestal profesional para 2 teclados.

- Fabricado en aluminio
- Capacidad de carga: Hasta 130 kg
- Guía de cables
- Brazos desmontables con gomas de protección
- Altura ajustable
- Fácil de transportar



MS-120BSE

Soporte para brazo de teclados MS-120

- Fabricado en plástico ABS
- Con perillas de ajuste



Bolsa con 1 pieza

MIN VENTA

1 pieza



MS-120BZC

Par de brazos cortos para pedestal de teclados MS-120

- Largo: 35 cm
- Fabricado en aluminio con caucho antiderrapante



Bolsa con 1 par

MIN VENTA

1 par



MS-120BZL

Par de brazos largos para pedestal de teclados MS-120

- Largo: 47 cm
- Fabricado en aluminio con caucho antiderrapante



Bolsa con 1 par

MIN VENTA

1 par



Caja con 1 pieza



MIN VENTA

1 pieza

PEDESTALES Y ACCESORIOS

Catálogo General MEXBUSA

Sonido que apasiona **ROMMIS**



MS-232

Pedestal para teclado tipo tijera, con doble barra y manija.

- Capacidad de carga: 50 kg
- Gomas antiderrapantes
- Fabricado con tubo rectangular de alta resistencia



Caja con 1 pieza



1 pieza

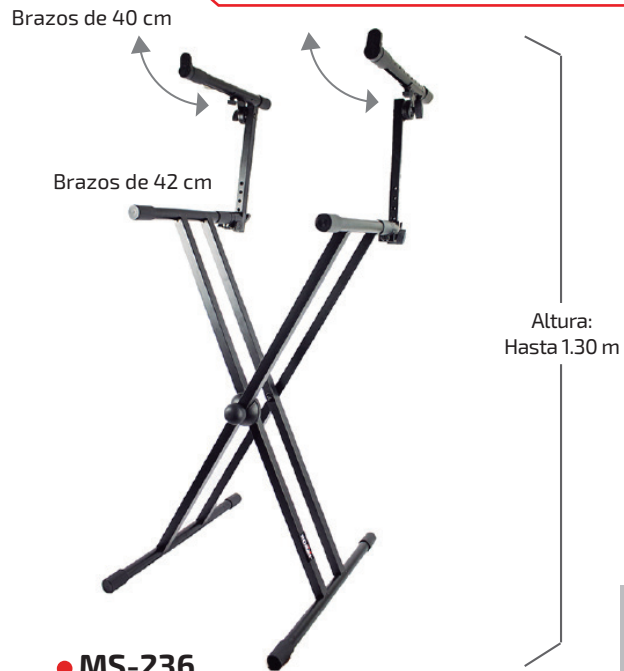

MS-236

Pedestal para dos teclados. Tipo tijera con perno.

- Base con ajuste de inclinación
- Capacidad de carga: 70 kg
- Fabricado con tubo rectangular de alta resistencia



Caja con 1 pieza



1 pieza



MS-232E

Pedestal para teclado tipo tijera, con doble barra y perno.

- Línea Estándar
- Capacidad de carga: 40 kg
- Gomas antiderrapantes
- Fabricado con tubo rectangular de alta resistencia



7 posiciones.
Entre 32.5 y 97 cm



Caja con 1 pieza



1 pieza



MS-236E

Pedestal para dos teclados. Tipo tijera con manija.

- Línea Estándar
- Base con ajuste de inclinación
- Capacidad de carga: 55 kg
- Fabricado con tubo rectangular de alta resistencia



Altura:
Hasta 1.30 m



Caja con 1 pieza



1 pieza



- **MS-239**
Banco metálico para tecladista.
- Altura ajustable de 40 a 60 cm
- Asiento acolchonado
- Color negro
- Base tipo tijera con gomas antiderrapantes



Caja con 1 pieza

MIN VENTA

1 pieza



- **MS-541**
Banco metálico para baterista.
- Altura ajustable de 40 a 60 cm
- Asiento acolchonado redondo
- Cromado
- Base tipo tripie con gomas antiderrapantes



Caja con 1 pieza

MIN VENTA

1 pieza



¡Visita nuestro catálogo musical!



Instrumentos



Fundas



Tahalí



Accesorios

Visitanos en:
www.mexbusa.com



PEDESTALES Y ACCESORIOS

Catálogo General MEXBUSA

Sonido que apasiona **ROMMIS**



Altura entre .60 y 1.20 m



Caja con 1 pieza

MIN VENTA

1 pieza



Charola de 34.8x48.5 cm

Altura entre .90 y 1.45 m



Caja con 1 pieza

MIN VENTA

1 pieza

MS-201

Pedestal de varilla plegable para partitura.

- Charola de 40x22 cm
- 3 secciones
- Sujeta hojas

MS-203

Atril profesional con charola metálica perforada para partitura.

- Soporte reforzado con perillas de ajuste individuales
- Charola de base amplia: 5 cm
- Tripié con tubos de acero de 30 mm de diámetro
- Ajuste de inclinación en la parte posterior



Altura entre .45 y 1.20 m

Rockers
MUSIC



Caja con 1 pieza

MIN VENTA

1 pieza



Charola de 33.3x49 cm

Altura entre .95 y 1.32 m

Rockers
MUSIC



Caja con 1 pieza

MIN VENTA

1 pieza

MS-201E

Pedestal de varilla para partitura. Línea Estándar.

- Altura ajustable de 0.45 a 1.20 m
- 3 secciones
- Sujeta hojas
- Incluye bolsa de tela, para mejor portabilidad

MS-203E

Atril profesional con charola metálica perforada para partitura. Línea Estándar.

- Soporte reforzado con perillas de ajuste individuales
- Con sujeta hojas
- Charola de 4.5 cm
- Tripié con tubos de acero de 26 mm de diámetro
- Ajuste de inclinación en la parte posterior

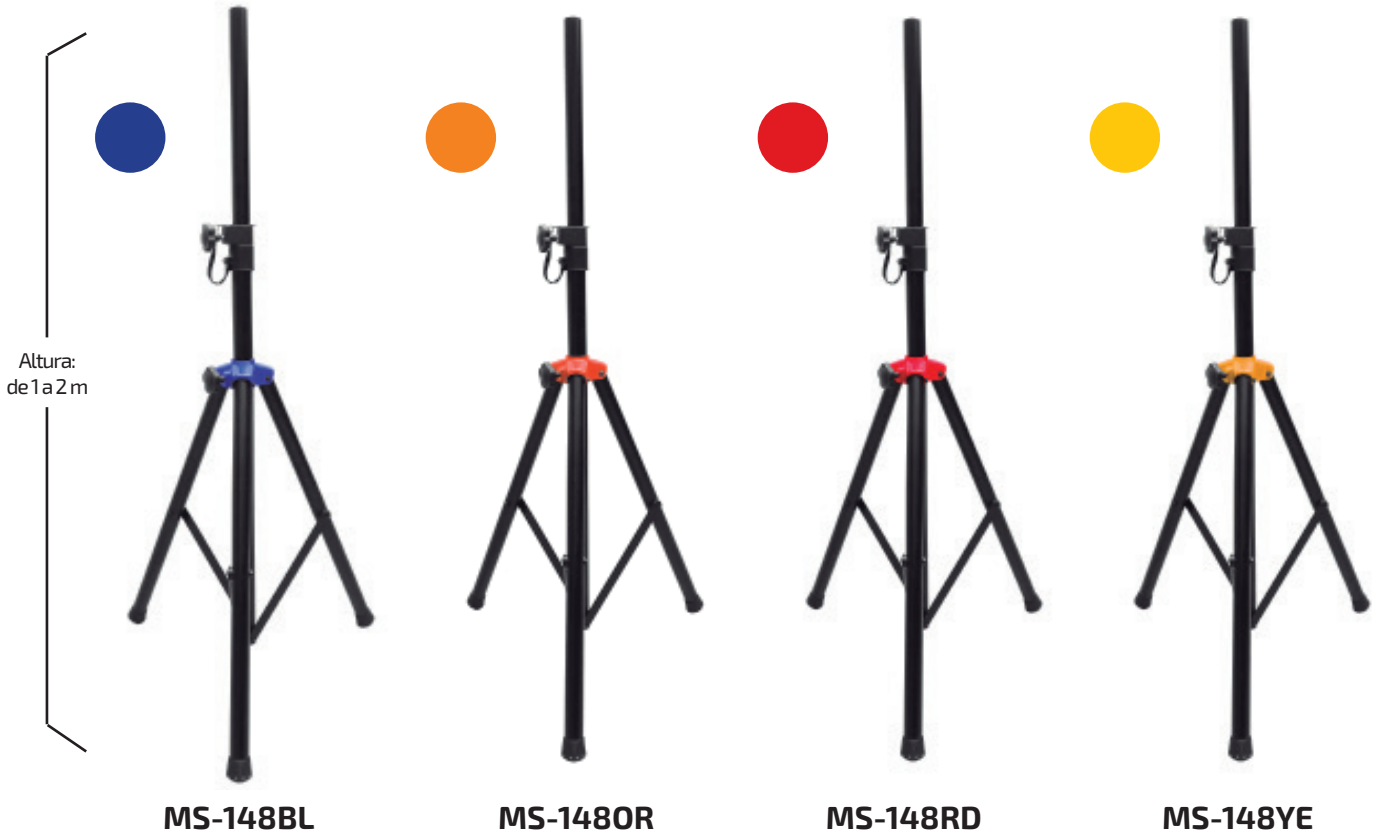

MS-148BL

MS-148OR

MS-148RD

MS-148YE

● Pedestal de piso para bafle.

- 5 alturas ajustables (perno incluido) - Capacidad de carga: 50 kg
- Fabricado en tubo de acero con grosor de 40 mm
- Base con tres puntos de apoyo y protección antiderrapante.



Caja con 1 pieza



1 pieza



● **MS-181**

Soporte de pared para bafle con ajuste de profundidad.

- Brazo de ajuste con inclinación y movimiento lateral de 180°
- Longitud del brazo: 36 cm
- Acabado mate
- Capacidad de carga: 25 kg
- Incluye llave Allen



Caja con 1 pieza



1 pieza



● **MS-183**

Soporte de pared para bafle.

- Brazo de ajuste con inclinación y movimiento lateral de 180°
- Longitud del brazo: 36 cm
- Acabado mate.
- Capacidad de carga: 25 kg
- Incluye llave Allen



Caja con 1 pieza



1 pieza



● **MS-097**

Base de hierro para soporte de bafle.

- Diámetro de inserción: 35 mm
- Diámetro base: 110 mm
- Profundidad: 90 mm



Bolsa con 1 pieza



1 pieza



● **MS-098**

Base de aluminio para soporte de bafle.

- Diámetro de inserción: 36 mm
- Diámetro base: 110 mm
- Profundidad: 75 mm



Bolsa con 1 pieza



1 pieza



MS-245

Base profesional para equipos de DJ.

- Perillas de ajuste, para altura y amplitud
- Fabricada en acero con cintas antiderrapantes
- Diseño ideal para laptop y controladores
- Ligero y fácil de transportar
- Altura ajustable: 24 a 33 cm
- Ancho ajustable: 34 a 45 cm
- Peso: 2.6kg



Caja con
1 pieza



1 pieza

NUEVO



MS-247

Soporte profesional para DJ.

- Especificaciones técnicas:
- Soporte para computadora portátil
 - Cuenta con nivel medio para otros dispositivos y/o accesorios
 - Ligero, portátil y plegable
 - Materiales de alta calidad y gran resistencia
 - Dimensiones: 306 x 267 x 252 mm.
 - Peso: 1.5 kgs.



Caja con
1 pieza



1 pieza

MS-246

Base profesional para DJ. Con charola y soporte de mesa.

- Perillas de ajuste, para altura y amplitud
- Incluye tornillos de seguridad para sujetarse a mesa o rack
- Fabricada en acero con cintas antiderrapantes
- Diseño ideal para laptop y controladores
- Ligero y fácil de transportar
- Altura ajustable: 24 a 33 cm
- Ancho ajustable: 34 a 45 cm
- Peso: 2.6 kg



Caja con
1 pieza



1 pieza



MS-121

Clamp para iluminación.

- Fabricado en acero
- Soporta hasta 20 kg
- Materiales de alta calidad y gran resistencia



Bolsa con
1 pieza



1 pieza



MS-250

Estructura para montaje de luces.

- Ideal para escenarios pequeños
- Capacidad de carga: 80 kg
- 2 Bases con tres puntos de apoyo y protección antiderrapante
- Incluye pernos de seguridad
- Fabricado en tubo de acero con grosor de 40 mm
- Peso: 21 kg



Caja con 1 pieza



1 pieza



Juntas de plástico.



MS-251 ◀

Pedestal con tubos de acero para luces de ambientación.

- Capacidad de carga: 40 kg
- Base con tres puntos de apoyo y protección antiderrapante
- Fabricado en tubo de acero con grosor de 40 mm
- Peso: 9 kg
- Acabado negro mate, de alta resistencia
- Incluye pernos de seguridad



Caja con 1 pieza



1 pieza



MS-254 ▶

Pedestal para luces y/o equipo de ambientación

- Capacidad de carga: 50 kg
- Sistema tipo polea para altura.
- Brazo para 6 equipos con tornillos de sujeción.
- Base con tres puntos de apoyo y protección antiderrapante
- Fabricado en tubo de acero con grosor de 40 mm
- Peso: 13 kg
- Acabado negro mate, de alta resistencia



Caja con 1 pieza



1 pieza

Panasonic



● HJE120BK

Audífonos manos libres. Panasonic

- Inalámbricos
- Alcance de 10 m
- Voz más clara y bajos precisos
- Pequeños y ligeros para mejor portabilidad
- Cable USB de carga de 10 cm
- Tiempo de reproducción: 4 h 20 m
- Noise cancelling



Blister con 1 pieza

1 pieza

OFERTA



● S2DUY-L676/R

- Manos libres para tus llamadas
- Control con reproductor
- Noise cancelling
- Compatible con computadora portátil, móvil, reproductor de MP3, tablet, etc.



Cable de 1.2 m



Entrada



Blister con 1 pieza



1 pieza

OFERTA



● X2OFFQ-823/GN

- Audífonos de botón
- Noise cancelling
- Compatible con computadora, laptop, móvil, reproductor de MP3, tablet, etc.



Cable de 1.2 m



Entrada



Bolsa con 1 pieza



1 pieza

OFERTA



Entrada



Cable de 1.2 m

OFERTA



Entrada



Cable de 1.2 m

OFERTA



Entrada



Cable de 1.2 m

● HP-111

- Audífonos Xtron intrauditvos.
- Con cable retráctil
 - Noise cancelling

● HP-125

- Audífonos Intrauditvos Xtron.
- Noise cancelling
 - Compatible con la mayoría de dispositivos

● HP-135

- Audífonos Intrauditvos Xtron.
- Noise cancelling
 - Compatible con gran cantidad de dispositivos

75 W
RMS



12"



12x15"



Caja con
1 pieza

MIN
VENTA

1 pieza

TH-16U

Trompeta de aluminio con unidad integrada.

- Ideal para perifoneo, voceo o publifusión móvil
- Para interior o exteriores
- Incluye accesorios de montaje
- Unidad: 20 Oz
- Impedancia: 8 Ω

100 W
RMS



14"



14x19.5"



Caja con
1 pieza

MIN
VENTA

1 pieza

TH-100U

Trompeta de aluminio con unidad integrada.

- Ideal para perifoneo, voceo o publifusión móvil
- Para sonorizar espacios abiertos o parques
- Para interior o exteriores
- Incluye accesorios de montaje
- Unidad: 25 Oz - Impedancia: 8 Ω

30 W
RMS



20x11.7
x23.2 cm



Caja con
1 pieza

MIN
VENTA

1 pieza

SP-136

Altoparlante rectangular (Tipo trompeta.)
Fabricado en plástico ABS.

- Potencia: 30 W - Alimentación: 12 Vcc
- Sensibilidad: 101 dB - Impedancia: 8 Ω
- Rango de frecuencia: 500 Hz — 5kHz
- Ideal para perifoneo

30 W
RMS



20x15.8
x23.2 cm



Caja con
1 pieza

MIN
VENTA

1 pieza

SH-106

Sirena rectangular de 2 tonos fabricada
en plástico ABS.

- Potencia: 30 W - Alimentación: 12 Vcc
- Consumo: 1000 mAh - Impedancia: 6 Ω
- Para interiores y exteriores
- Puede ser fijada a cualquier estructura



● MEG-066

Megáfono con micrófono.

Funciones:

Parlante, grabación, sirena y micrófono con control de volumen.

- 50 W de potencia
- Rango de 500 m de alcance
- Entrada auxiliar para conector de 3.5 mm
- Perfecto para uso interior y exterior
- Excelente para conferencias, conciertos, eventos, tours y más
- Sirena y micrófono con volumen
- Grabación de hasta 15 segundos en memoria USB o SD
- Reproduce archivos de audio de memoria USB o SD
- Batería de litio recargable incluida
(Opción a funcionar con 4 baterías D no incluidas)
- Correa ajustable para fácil transportación
- Acabado en plástico ABS brillante que permite el uso constante
- Protección de PVC en la parte frontal para evitar el maltrato



Caja con 1 pieza



1 pieza

33 cm

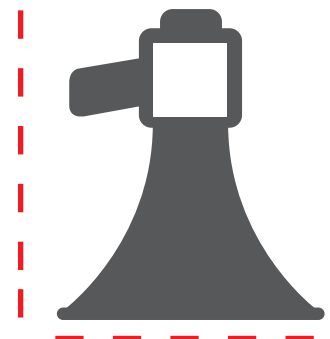

22.5 cm (diámetro)



● **MEG-067** Usa 4 baterías AA no incluidas.

MEG-067B Con batería recargable.

Mini megáfono con micrófono incorporado.

Funciones:

Parlante, grabación, sirena y micrófono con control de volumen.

- Rango: 200 m
- Potencia: 15 W
- Micrófono incorporado. -Incluye correa ajustable
- Batería incluida en el modelo MEG-067B
(Opción para batería de litio recargable de ALTA calidad o 4 pilas AA no incluidas)
- Perfecto para uso interior y exterior
- Excelente para conferencias, conciertos, eventos, tours y más
- Mango abatible
- Acabado en plástico ABS brillante que permite el uso constante
- Protección de PVC en la parte frontal para evitar el maltrato



Caja con
1 pieza



1 pieza

20.5 cm

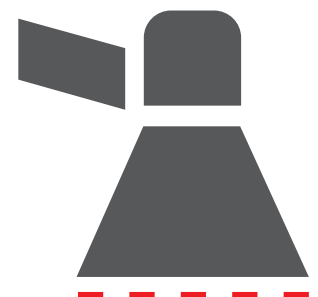

13.7 cm (diámetro)

CABLES DE AUDIO

Catálogo General MEXBUSA

Sonido que apasiona **ROMMIS**



- **MS-401** 3 m
- **MS-402** 6 m



Cable de audio con conectores TS de 6.3 mm.

- Conector de baquelita, con resorte
- Color negro



Brazaletes



MIN VENTA

1 pieza



- **MS-403** 3 m
- **MS-404** 6 m



Cable de audio con conectores TS de 6.3 mm. Puntas doradas.

- Conectores dorados
- Color negro



Brazaletes



MIN VENTA

1 pieza



- **MS-405BK** 3 m
- **MS-405BL** 3 m
- **MS-405RD** 3 m
- **MS-406BK** 6 m
- **MS-406BL** 6 m



Cable de audio con conectores TS de 6.3 mm. Con un conector reforzado en L.



Brazaletes



MIN VENTA

1 pieza



- **MS-407BK** 10 m
- **MS-407BL** 10 m



Cable de audio en espiral con conectores TS de 6.3 mm.

- Con un conector en L, tipo "pancake"
- Reforzado



Brazaletes



MIN VENTA

1 pieza



- **MS-422**
- Juego de 10 cables de audio con conectores TS de 6.3 mm.
- Ideal para parcheo



Cable de 1 m



Brazaletes



MIN VENTA

1 pieza



- **MS-431BK** 3 m
- **MS-432BK** 6 m



Cable de audio con conectores TS de 6.3 mm. Cubierta de termofit.

- Color negro
- Puntas doradas



Brazaletes



MIN VENTA

1 pieza



Complementa con:



PMX-8180
Mezcladora
amplificada de 8
canales.



MX-10CH
Mezcladora pasiva
de 10 canales.

¡Proximamente varios
modelos de guitarras
eléctricas!





- **MS-470BK** 3 m
- **MS-471BK** 6 m
- **MS-472BK** 10 m



Cable de audio profesional. De conector XLR a conector TS de 6.3 mm

- Color negro
- Conector TS con punta dorada



Brazaletes



1 pieza



- **MS-491BK** 3 m
- **MS-492BK** 6 m
- **MS-493BK** 10 m
- **MS-494BK** 15 m



Cable de audio profesional. Con conectores XLR.

- Color negro



Brazaletes



1 pieza



- **CA-162** 3.6 m
- **CA-163** 7.5 m



Cable de audio de conector XLR a conector TS de 6.3 mm

- Color negro



Brazaletes



1 pieza



- **CA-164** 3.6 m



Cable de audio con conectores XLR.

- Color negro



Brazaletes



1 pieza



- **MS-410BK**
- Cable de audio con conectores MIDI.

- Conectores DIN de 5 pines
- Sirve para conectar ordenadores o dispositivos entre sí
- Color negro



Cable de 3 m



Brazaletes



1 pieza



- **MS-630** 6 m
- **MS-631** 10 m



Cable de audio con conectores Speak-On macho.

- Conectores macho
- Cubierta de PVC
- Uso rudo



Brazaletes



1 pieza



- **MS-634**
- Cable de audio de conector Speak-On macho a conector TS de 6.3 mm

- Cubierta de PVC
- Uso rudo



Cable de 6 m



Brazaletes



1 pieza



Complementa con:



MX-802BT
Mezcladora pasiva de 8 canales.



MS-247
Soporte profesional para DJ.

CA-102

Cable auxiliar de conector TRS de 3.5 mm a 2 conectores RCA macho.

- Tipo "Y"
- Estándar
- Forro de aislante negro



Cable de 1.80 m



Bolsa con 1 pieza



1 pieza



CA-102G

Cable auxiliar de conector TRS de 3.5 mm a 2 conectores RCA macho. Puntas doradas.

- Tipo "Y"
- Reforzado
- Forro de aislante negro



Cable de 1.80 m



Bolsa con 1 pieza



1 pieza



CA-102BK CA-102BL CA-102YE

Cable auxiliar de conector TRS de 3.5 mm a 2 conectores RCA macho.

- Tipo "Y" - Reforzado
- Conectores identificados
- Forro de aislante negro



Cable de 1.80 m



Bolsa con 1 pieza



1 pieza



CA-153

Cable auxiliar de conector RCA hembra a dos conectores RCA macho.

- Tipo "Y"
- Forro cristal



Cable de 15 m



Bolsa con 1 pieza



1 pieza



CA-108RL

Cable auxiliar de conector RCA macho a dos conectores RCA hembra.

- Tipo "Y"
- Estándar
- Forro de aislante negro



Cable de 15 cm



Bolsa con 1 pieza



1 pieza



CA-133RL

Cable auxiliar de conector RCA hembra a dos conectores RCA macho.

- Tipo "Y"
- Estándar
- Forro de aislante negro



Cable de 15 cm



Bolsa con 1 pieza



1 pieza



CA-104BK CA-105BK CA-127BK CA-132BK

Extensión RCA reforzada con 2 conectores macho en cada extremo.

- Conectores identificados
- Reforzado
- Forro de aislante negro



0.90 m

1.80 m

3.60 m

7.50 m



Bolsa con 1 pieza



1 pieza



CA-104BL CA-105BL CA-127BL

Extensión RCA reforzada con 2 conectores macho en cada extremo.

- Conectores identificados
- Reforzado
- Forro de aislante azul



0.90 m

1.80 m

3.60 m



Bolsa con 1 pieza



1 pieza





- **CA-220RL** .45 m
- CA-221RL** .90 m
- CA-222RL** 1.8 m
- CA-224RL** 3.6 m
- CA-225RL** 4.5 m
- CA-226RL** 6 m
- CA-228RL** 7.5 m



Extensión RCA con 2 conectores macho en cada extremo. Reforzada. Línea Premium.

- Puntas doradas
- Cable cristal
- Reforzado



Blister con 1 pieza



1 pieza



- **CA-220E** .45 m
- CA-221E** .90 m
- CA-222E** 1.8 m
- CA-224E** 3.6 m
- CA-225E** 4.5 m
- CA-226E** 6 m
- CA-228E** 7.5 m



Extensión RCA con 2 conectores macho en cada extremo. Línea Estándar.

- Puntas doradas
- Cable cristal.



Bolsa con 1 pieza



1 pieza



- **CA-104** 0.90 m
- CA-132** 7.5 m



Extensión RCA con 2 conectores macho en cada extremo.

- Estándar
- Forro de aislante negro



Bolsa con 1 pieza



1 pieza



- **CA-157** .90 m
- CA-158BK** 1.80 m
- CA-158BL** 1.80 m



Cable auxiliar con conectores TRS de 3.5 mm

- Estándar
- Color negro
- Compatible con gran cantidad de dispositivos



Bolsa con 1 pieza



1 pieza

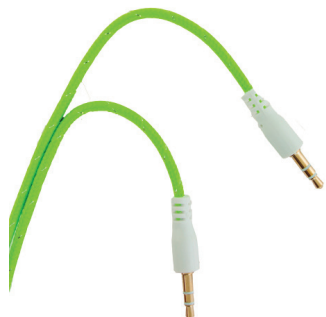

- **CA-3535BK-3M** ●
- CA-3535BL-3M** ●
- CA-3535GN-3M** ●
- CA-3535RD-3M** ●
- CA-3535WH-3M** ○



3m

Cable auxiliar con conectores TRS de 3.5 mm tipo agujeta.

- Forro de agujeta



Bolsa con 1 pieza



1 pieza

OFERTA



- **CA-1183**
- Cable plug 3.5 a 3.5 espiral
- Longitud: 32 cm
 - Disponible en colores varios



Bolsa con 1 pieza



1 pieza



Bolsa de plástico



50 piezas

● **PL-101R**
Conector TS de 6.3 mm de plástico. Con resorte.



Bolsa de plástico



5 piezas

● **PL-103**
Conector TS de 6.3 mm con capucha de baquelita.



Bolsa de plástico



10 piezas

● **PL-103-E**
Conector TS de 6.3 mm con capucha de baquelita. - Modelo: Estándar



Bolsa de plástico



2 piezas

● **PL-422RL**
Conector TS de 6.3 mm con cubierta de hule y punta dorada.



Bolsa de plástico



20 piezas

● **PL-102R**
Conector TS de 6.3 mm de metal. Con resorte.



Bolsa de plástico



10 piezas

● **PL-102RL**
Conector TS de 6.3 mm de metal. Con resorte y anillo de baquelita.



Bolsa de plástico



20 piezas

● **PL-104R**
Conector TRS de 6.3 mm de metal. Con resorte.



Bolsa de plástico



10 piezas

● **PL-104RL**
Conector TRS de 6.3 mm de metal. Con resorte y anillo de baquelita.



Bolsa de plástico



10 piezas

● **PL-140**
Conector TS de 6.3 mm jumbo. Metálico con aislante.



Bolsa de plástico



10 piezas

● **PL-145**
Conector TS de 6.3 mm jumbo. Con arillo metálico.



Bolsa de plástico



5 piezas

● **PL-165BK**
Conector TS de 6.3 mm jumbo con punta dorada y protector de cable. - Conector de metal con base de plástico



Bolsa de plástico



10 piezas

● **PL-165BK-E**
Conector TS de 6.3 mm jumbo con punta dorada y protector de cable. - Conector de metal con base de plástico - Modelo: Estándar



Bolsa de plástico



20 piezas

● **PL-105**
Conector TS de 6.3 mm en escuadra. Metálico. - Tipo "Pancake"



Bolsa de plástico



5 piezas

● **PL-120**
Conector TS de 6.3 mm en escuadra. Metálico reforzado.



Bolsa de plástico



10 piezas

● **PL-120E**
Conector TS de 6.3 mm en escuadra. Metálico reforzado. - Modelo: Estándar



Bolsa de plástico



5 piezas

● **PL-122RL**
Conector XLR macho de 3 pines. Con aislante y protector para cable.



Bolsa de plástico
MIN VENTA
5 piezas

● **PL-123RL**
Conector XLR macho de 3 pines. Metálico, con aislante y seguro.



Bolsa de plástico
MIN VENTA
5 piezas

● **PL-126RL**
Conector XLR macho de 3 pines. Metálico, con resorte y seguro.



Bolsa de plástico
MIN VENTA
5 piezas

● **PL-128**
Conector XLR macho de 3 pines. Metálico, con aislante, abrazadera y seguro.



Bolsa de plástico
MIN VENTA
5 piezas

● **PL-128RL**
Conector XLR macho de 3 pines. Con aislante y protector para cable.



Bolsa de plástico
MIN VENTA
5 piezas

● **PL-152BK** ●
● **PL-152BL** ●
● **PL-152RD** ●
Conector XLR macho de 3 pines, con seguro y aislante.



Bolsa de plástico
MIN VENTA
10 piezas

● **PL-152BK-E** ●
● **PL-152BL-E** ●
Conector XLR macho de 3 pines, con seguro y aislante.
- Modelo: Estándar



Bolsa de plástico
MIN VENTA
5 piezas

● **PL-156BK** ●
● **PL-156BL** ●
● **PL-156RD** ●
Conector XLR macho de 3 pines, con seguro.



Bolsa de plástico
MIN VENTA
10 piezas

● **PL-155**
Conector XLR macho de 3 pines. De metal para chasis.



Bolsa de plástico
MIN VENTA
50 piezas

● **PL-107RL**
Conector TS de 3.5 mm de plástico. Con resorte.



Bolsa de plástico
MIN VENTA
50 piezas

● **PL-109**
Conector TRS de 3.5 mm de plástico. Con resorte.



Bolsa de plástico
MIN VENTA
10 piezas

● **PL-108**
Conector TRS de 3.5 mm de metal. Con protector de cable de plástico.



Bolsa de plástico
MIN VENTA
10 piezas

● **PL-108-E**
Conector TRS de 3.5 mm con protector de cable.
- Modelo: Estándar



Bolsa de plástico
MIN VENTA
50 piezas

● **PL-113BK** ●
● **PL-113RD** ●
Conector RCA macho de plástico.



Bolsa de plástico
MIN VENTA
50 piezas

● **PL-114BK** ●
● **PL-114RD** ●
Conector RCA macho de metal. Con resorte.



Bolsa de plástico
MIN VENTA
10 piezas

● **PL-114GBK** ●
● **PL-114GRD** ●
Conector RCA macho, dorado, de metal. Con resorte.



Bolsa de plástico
MIN VENTA
25 piezas

● **PL-115BK** ●
● **PL-115RD** ●
Conector RCA macho de plástico. Con resorte.

CONECTORES

Catálogo General MEXBUSA

Sonido que apasiona **ROMMIS**



Bolsa de plástico

MIN VENTA

10 piezas

● **PL-146BK**
● **PL-146RD**

Conector doble banana.
- Punta metálica



Bolsa de plástico

MIN VENTA

10 piezas

● **PL-146GBK**
● **PL-146GRD**

Conector doble banana.
- Punta dorada



Bolsa de plástico

MIN VENTA

10 piezas

● **PL-147GBK**
● **PL-147GRD**

Conector doble banana metálico.
- Puntas y bornes dorados



Bolsa de plástico

MIN VENTA

25 piezas

● **PL-119BK**
● **PL-119RD**

Conector banana de plástico.
- Punta metálica



Bolsa de plástico

MIN VENTA

50 piezas

● **PL-200BK**
● **PL-200RD**

Conector banana de baquelita con tornillo de sujeción.



Bolsa de plástico

MIN VENTA

4 piezas

● **PL-256**

Conector Speak-On macho de 4 polos con seguro.



Bolsa de plástico

MIN VENTA

20 piezas

● **JA-102RL**

Conector TS hembra de 6.3 mm
- De circuito abierto para chasis



Bolsa de plástico

MIN VENTA

20 piezas

● **JA-104**

Conector TS hembra de 6.3 mm de metal. Con resorte.



Bolsa de plástico

MIN VENTA

5 piezas

● **JA-122RL**

Conector XLR hembra de 3 pines. Con aislante y protector para cable.



Bolsa de plástico

MIN VENTA

5 piezas

● **JA-123RL**

Conector XLR hembra de 3 pines. Metálico con aislante y seguro.



Bolsa de plástico

MIN VENTA

5 piezas

● **JA-125**

Conector XLR hembra de 3 pines. Metálico, con aislante, seguro y abrazadera.



Bolsa de plástico

MIN VENTA

5 piezas

● **JA-125RL**

Conector XLR hembra de 3 pines. Metálico, con aislante y protector para cable.



Bolsa de plástico

MIN VENTA

5 piezas

● **JA-126RL**

Conector XLR hembra de 3 pines. Metálico con resorte y seguro.



Bolsa de plástico

MIN VENTA

5 piezas

● **JA-131**

Conector XLR hembra de metal, para chasis. Con seguro.



Bolsa de plástico

MIN VENTA

5 piezas

● **JA-155**

Conector XLR hembra de metal, para chasis.



Bolsa de plástico

MIN VENTA

10 piezas

● **JA-155P**

Conector XLR hembra de plástico para chasis.



Bolsa de plástico



5 piezas

- **JA-152BK**
- **JA-152BL**
- **JA-152RD**

Conector XLR hembra de 3 pines con aislante y seguro.



Bolsa de plástico



10 piezas

- **JA-152BK-E**
- **JA-152BL-E**

Conector XLR hembra con aislante y seguro. - Modelo: Estándar.



Bolsa de plástico



5 piezas

- **JA-156BK**
- **JA-156BL**
- **JA-156RD**

Conector XLR hembra de 3 pines, con seguro.



Bolsa de plástico



20 piezas

- **JA-109**
- Conector TRS de 3.5 mm encapsulado para circuito impreso. De 5 pines



Bolsa de plástico



50 piezas

- **JA-113BK**
- **JA-113RD**

Conector RCA hembra de plástico. Con resorte.



Bolsa de plástico



10 piezas

- **JA-114BK**
- **JA-114RD**

Conector RCA hembra de metal. Con resorte.



Bolsa de plástico



10 piezas

- **JA-114GBK**
- **JA-114GRD**

Conector RCA hembra de metal. Con resorte.



Bolsa de plástico



10 piezas

- **JA-201BK**
- **JA-201RD**

Conector hembra chico. Tipo banana, con borne para chasis.



Bolsa de plástico



10 piezas

- **JA-202BK**
- **JA-202RD**

Conector hembra mediano. Tipo banana, con borne para chasis.



Bolsa de plástico



10 piezas

- **JA-203BK**
- **JA-203RD**

Conector hembra grande. Tipo banana, con borne para chasis.



Bolsa de plástico



4 piezas

- **JA-256**
- Conector Speak-On hembra de 4 polos. Para chasis.

- Plástico de alta resistencia
- Redondo





● **AD-099**
Adaptador de conector TRS hembra de 2.5 mm a conector TRS macho de 3.5 mm.



● **AD-103**
Adaptador de conector TRS hembra de 6.3 mm a conector TRS macho de 3.5 mm.



● **AD-108**
Adaptador de conector TS hembra de 6.3 mm a conector TS macho de 3.5 mm.



● **AD-104**
Adaptador de conector TRS hembra de 3.5 mm a TRS macho de 6.3 mm.



● **AD-105**
Adaptador metálico de conector TRS hembra de 3.5 mm a conector TRS macho de 6.3 mm.



● **AD-117**
Adaptador de conector RCA hembra a conector TS macho de 6.3 mm.



● **AD-118**
Adaptador de conector TS hembra de 3.5 mm a conector TS macho de 6.3 mm.



● **AD-119**
Adaptador metálico de conector RCA hembra a conector TS macho de 6.3 mm.



● **AD-130**
Adaptador metálico de conector XLR hembra a conector TS macho de 6.3 mm.



● **AD-272**
Adaptador de 2 conectores TS hembra de 6.3 mm a 1 conector TRS macho de 6.3 mm.



● **AD-271**
Adaptador de 2 conectores RCA hembra a 1 conector TS macho de 6.3 mm.



● **AD-122**
Adaptador de 2 conectores RCA hembra a 1 conector TS macho de 6.3 mm.





AD-111
Cople para conectores RCA por cada lado.



AD-115
Adaptador de 2 conectores TRS hembra de 3.5 mm a 1 conector TS macho de 3.5 mm.



AD-187
Adaptador de 2 conectores RCA hembra a 1 conector RCA macho.



AD-188
Adaptador de 2 conectores RCA hembra a 1 conector TRS macho de 3.5 mm.



AD-211
Cople doble para conectores RCA por cada lado.



AD-190
Cople triple para conectores RCA por cada lado.



AD-106
Cople metálico para conectores TS de 6.3 mm por lado.





600 W
RMS



RKP-15100

Bocina redonda profesional ROMMS con cono de cartón. Pueden utilizarse como refacciones para bafle o para construir tu propio equipo de sonido.

- Suspensión de tela
- Bornes metálicos
- Bobina de 3"
- 100 Oz. -8 Ω -98 dB
- Frecuencia: 30-3500 Hz



15"



Caja con 1 pieza



1 pieza



800 W
RMS



RKP-18120

Bocina redonda profesional ROMMS con cono de cartón. Pueden utilizarse como refacciones para bafle o para construir tu propio equipo de sonido.

- Suspensión de tela
- Bornes metálicos
- Bobina de 4"
- 120 Oz. -8 Ω -98 dB
- Frecuencia: 30-3500 Hz



18"



Caja con 1 pieza



1 pieza



● **RTW-150**
Tweeter flor de 2,5"

- Tipo Leson
- De plástico y con rejilla
- Impedancia: 4-8 Ω
- Sensibilidad: 108 dB

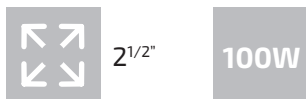

● **RTW-160**
Tweeter cuadrado de 2 3/4"

- Tipo Leson tlc-5
- De plástico con rejilla
- Impedancia: 4-8 Ω
- Sensibilidad: 102 dB



● **RTW-201**
Juego de tweeters de 1.25"

- Tipo Leson
- Plástico rígido
- Impedancia: 4-8 Ω
- Sensibilidad: 102 dB

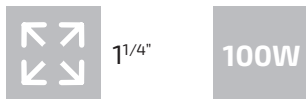

● **RTW-202**
Tweeter redondo de 2,5"

- Tipo Leson tlc-5
- Impedancia: 4-8 Ω
- Sensibilidad: 108 dB



CONOCE NUESTRA NUEVA LÍNEA AUTOMOTRIZ





● **SPT-203**
Tweeter redondo con cono de cartón.

- Canastilla metálica
- 8 Ω



● **SPT-1602**
Tweeter redondo con cono de cartón.

- Canastilla metálica con orejas
- Doble imán
- 6 Ω



● **SPT-1825**
Tweeter redondo con cono de cartón negro.

- Con orejas
- Doble imán
- 8 Ω



● **SPW-1655**
Bocina redonda con cono de cartón.

- Doble imán
- 6 Ω



● **STB-318** Negro
STB-319 Plata
Tweeter redondo.

- Bobina de voz:
- 1 Imán Ferrita de 8 Oz
- 4/ 8 Ω
- Sensibilidad: 101dB



● **STB-941** 150 W
Tweeter piezoeléctrico cuadrado.

- 4/ 8 Ω
- Sensibilidad: 100 dB



● **STB-944BL** 150 W
Tweeter piezoeléctrico cuadrado. Con luz audio rítmica.

- 4/ 8 Ω
- Sensibilidad: 100 dB



● **TW-10**
Tweeter tipo flor.

- Fabricado en plástico rígido
- Impedancia: 4-8 Ω
- Sensibilidad 93 dB





TW-244

Tweeter piezo eléctrico cuadrado con filtro.

- Fabricado en plástico rígido
- Impedancia: 4-8 Ω
- Sensibilidad 99 dB
- Imán de 20 Oz

3.2" 400W

Caja con 1 pieza MIN VENTA 1 pieza



RTW-149

Tweeter sin rejilla.

- Fabricada en plástico rígido
- Impedancia: 4/8 Ω
- Sensibilidad: 108 dB
- Sin rejilla

2.5" 100W

Caja con 1 pieza MIN VENTA 1 pieza



SP-146

Bocina semiredonda con cono de cartón.

- Canastilla metálica
- Doble imán de 6 Oz
- 6 Ω

4" 80W

Empaque de cartón MIN VENTA 1 pieza



SP-434

Bocina semiredonda con cono de cartón y suspensión de aire.

- Canastilla metálica
- Imán Ferrita de 5.3 Oz
- 4/8 Ω

4" 15W

Caja con 1 pieza MIN VENTA 1 pieza

OFERTA



SPV-15

Bocina rectangular.

- Imán Ferrita de 8 Oz
- 4/8 Ω

13.7 x 7.7 cm 5W

Caja con 1 pieza MIN VENTA 1 pieza



● CXR-300

Crossover profesional de 3 canales.

- Mute y fase inversa
- Corte de frecuencia ajustable
- Impedancia: 4-8 Ω



● TL-120NG

● Negro

Chico
1.20x45m

● TL-120GO

● Gris Oxford

● TL-180NG

● Negro

Grande
1.80x45m

● TL-180GO

● Gris Oxford

Tela para forro de bafles.

- Fabricada en polipropileno
- Gramaje promedio: 281g/m² *Puede variar
- Espesor promedio de 94 milésimas de pulgada (2.35mm)

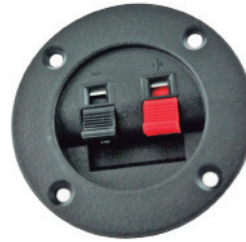

● AU-102

Terminal redonda con conectores de presión polarizados.

- De plástico rígido para atornillar
- No incluye pijas



● AU-103RL

Terminal rectangular con bornes polarizados.

- De plástico rígido para atornillar
- No incluye pijas



● AU-105

Terminal cuadrada con conectores de presión polarizados.

- De plástico rígido para atornillar
- No incluye pijas

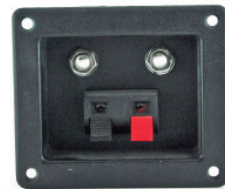

● AU-129

Terminal rectangular con conectores de presión polarizados y conectores TS de 6.3 mm hembra.

- De plástico rígido para atornillar
- No incluye pijas



● BF-01

Clamp con pija para rejilla.

- De plástico rígido



● BF-010

Esquinero metálico redondeado para dos pijas.

- No incluye pijas





- No incluye pijas

BF-011

Esquinero metálico redondeado para tres pijas.



4.7x3.3 cm



Bolsa con 20 piezas



20 piezas



- No incluye pijas

BF-012

Esquinero metálico cuadrado para dos pijas.



3.2x3.2 cm



Bolsa con 20 piezas



20 piezas



- No incluye pijas

BF-111

Esquinero de plástico cuadrado para 4 pijas.



5.5x3.4 cm



Bolsa con 20 piezas



20 piezas



BF-104

Difusor de 10x5" de plástico rígido. Con rosca plástica.



Bolsa con 1 pieza



1 pieza



BF-147

Difusor de 14x7" de plástico rígido. Con rosca metálica.



Bolsa con 1 pieza



1 pieza



BF-155

Difusor de 15x5" de plástico rígido. Con rosca metálica.



Bolsa con 1 pieza



1 pieza

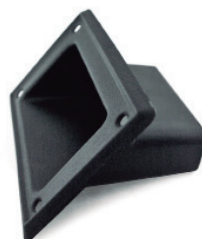

BF-115

Agarradera de 8.5x13.5 cm de plástico rígido.



Bolsa con 1 pieza



1 pieza



- Incluye pijas

BF-120

Agarradera de plástico suave, tipo maleta, con herrajes.



25 cm



Bolsa con 1 pieza



1 pieza



BF-124

Agarradera metálica tipo mariposa de 4x6".

- Acabado mate. Color negro



Bolsa con 1 pieza



1 pieza



BF-126

Agarradera metálica de 3x7x9".

- Acabado mate. Color negro



Bolsa con 1 pieza



1 pieza

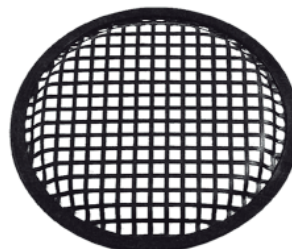

BF-12 12"
BF-15 15"

Rejilla metálica redonda de malla abierta para bocina.



Bolsa con 1 pieza



1 pieza



BF-65 6.5"
BF-69 6x9"

Rejilla de malla cerrada sin tornillos.

- De plástico rígido



Bolsa con 1 pieza



1 pieza



BF-101
Respiradero con rejilla.
- Fabricado en plástico rígido
- Malla abierta



2x1^{3/4}"



Bolsa con 1 pieza



1 pieza



DV-103
Driver grande de compresión tipo piezo
75/ 300 W
- Impedancia: 4-8Ω
- Sensibilidad: 102dB



Bolsa con 1 pieza



1 pieza



DV-310
Driver de 100W RMS con imán de ferrita.



Bolsa con 1 pieza



1 pieza

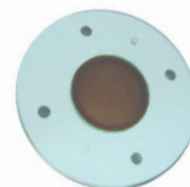

DV-210
Diafragma de repuesto para driver DV-310.



Bolsa con 1 pieza



10 piezas



DV-244
Diafragma de repuesto para driver DV-244.



Bolsa con 1 pieza



10 piezas



DV-246
Diafragma de repuesto para tweeter bala TW-246.



Caja con 1 pieza



10 piezas

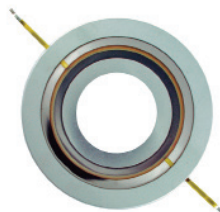

DV-257
Diafragma de repuesto para tweeter bala TW-257.



Blíster con 1 pieza



10 piezas



DSC-12 12"
DSC-15 15"
Diafragma de repuesto con bornes.



Caja con 1 pieza



1 pieza



VC-12 12"
VC-15 15"
Bobina de repuesto.



A granel



1 pieza



TF-15
Transformador **toroidal** para amplificador.

Input:
0-115V 50 Hz/60Hz negro-rojo
Output:
40 V-0-40 V azul-negro-azul
14.5 V-0-14.5 V blanco-negro-blanco
0-12 V amarillo-verde



A granel



1 pieza